



PLASMA 6

OWNER'S MANUAL



www.scott-sports.com



WWW.SCOTT-SPORTS.COM

The Plasma 6 should be adjusted exactly to the rider for maximum safety and rideability.

Please contact your authorized SCOTT dealer for advice in order to avoid technical problems or any harm.

Contents

Technical Data.....	3
Handlebars & Cockpit.....	4
Rear & Front Dropouts.....	6
Seatpost & Saddle Clamps.....	8
Hydration System.....	9
Warranty.....	12

► Geometry/Technical Data Plasma 6

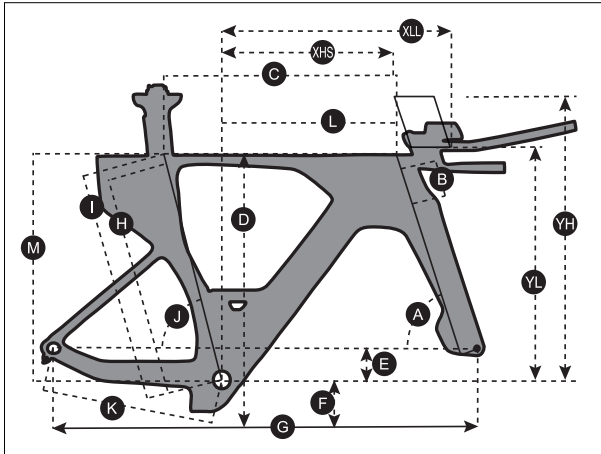

Headtube Diameter:
1 1/4" - 1 1/4" Drop In IS52/31.8 - IS46/34

BB Housing: **PF BB 86**

Max. Tyre Size Front and Rear: **30mm**

Rear Tyre Clearance Behind Seat tube: **Minimum 5mm**

Seatpost Saddle Clamps: **7x7mm, 8x8.5mm, 7x9.6mm**

Shifting: Electronic: **Di2, Sram AXS**

Max Brake Disc Size Front and Rear: **160mm**

Geometry	XS/49	S/52	M/54	L/56	XL/58
A head tube angle	72.5 °	72.5 °	72.5 °	72.5 °	72.5 °
B head tube length	71.5 mm	71.5 mm	87.0 mm	108.0 mm	124.0 mm
C top tube horizontal	509.3 mm	529.3 mm	555.8 mm	582.9 mm	609.5 mm
D standover height	746.0 mm	746.0 mm	795.8 mm	815.8 mm	831.1 mm
E BB offset	-75.0 mm	-75.0 mm	-75.0 mm	-75.0 mm	-75.0 mm
F BB height	261.0 mm	261.0 mm	261.0 mm	261.0 mm	261.0 mm
G wheel base	962.0 mm	982.0 mm	1,011.7 mm	1,043.0 mm	1,072.8 mm
H BB center to toptube center	493.0 mm	493.0 mm	542.4 mm	562.3 mm	577.5 mm
I BB center to top of seat-tube	503.0 mm	503.0 mm	552.4 mm	572.3 mm	587.5 mm
J seat angle	75.2 °	75.2 °	75.2 °	75.2 °	75.2 °
K chainstay	410.0 mm	410.0 mm	410.0 mm	410.0 mm	410.0 mm
L reach	372.5 mm	392.5 mm	417.5 mm	442.5 mm	467.5 mm
M stack	520.0 mm	520.0 mm	535.0 mm	555.0 mm	570.0 mm
K chainstay MIN	403.0 mm	403.0 mm	403.0 mm	403.0 mm	403.0 mm
K chainstay MAX	413.0 mm	413.0 mm	413.0 mm	413.0 mm	413.0 mm
YL Pads stack LOW	540.0 mm	540.0 mm	555.0 mm	575.0 mm	590.0 mm
YH Pads stack HIGH	660.0 mm	660.0 mm	675.0 mm	695.0 mm	710.0 mm
XH/S Pads reach HIGH/SHORT	362.2 mm	382.2 mm	407.2 mm	432.2 mm	457.2 mm
XL/L Pads reach LOW/LONG	500.0 mm	520.0 mm	545.0 mm	570.0 mm	595.0 mm

► Handlebars & Cockpit

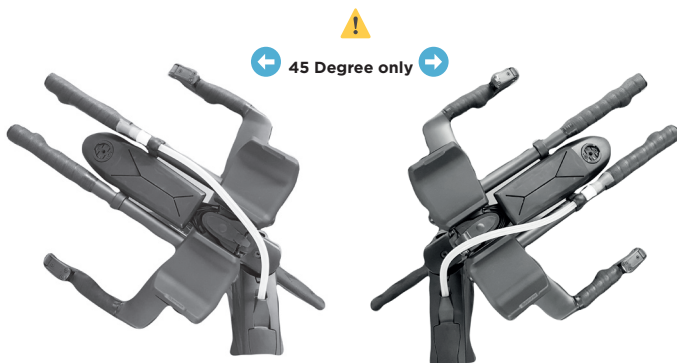

When riding, transporting, or storing your Plasma 6 take note of the limited turning rotation of the handlebars and fork.

Do not force them passed 45 degrees

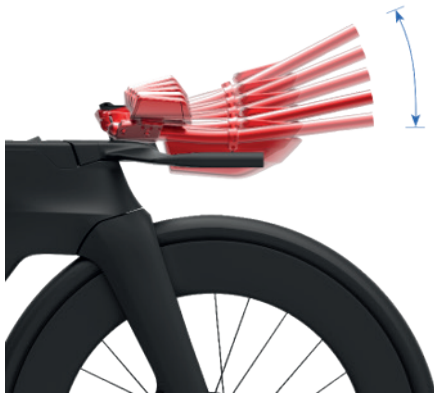

The adjustment of the tilt on the handlebar extensions, plus the height adjustment on the central pillar should only be carried out by your Authorised Scott Dealer.



The correct adjustments and torques must be abided by.

▶ Continued

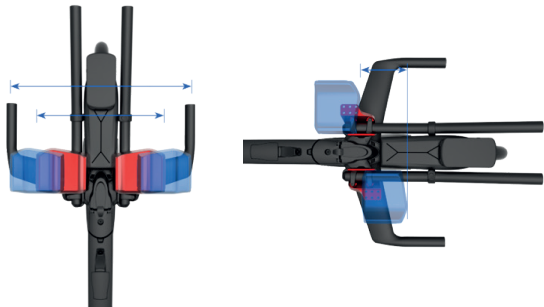

The width, forward and backward adjustment of the pad can be adjusted.



⚠ Tighten only two bolts to 5 Nm, with the addition of Blue Loctite.



Make sure the arm pads are located with the leading edge forward.

In this position the pads will provide the best support.

▶ Continued

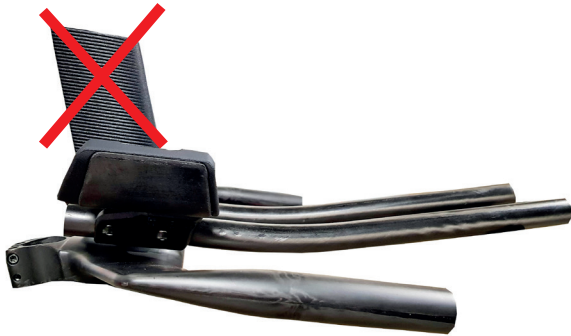

⚠ Once your Scott Dealer has adjusted your cockpit to your desired position do not ride your bike without cutting the central mast to the correct length.

Also make sure that your position is compatible with the base handlebars you are using. Both flat and elevated are available.

▶ Rear And Front Dropouts

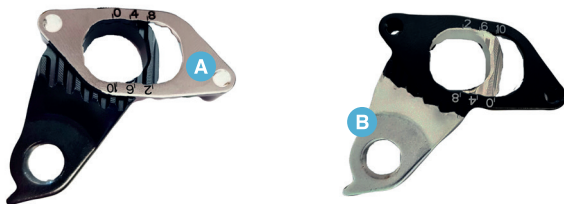

The rear dropout on the drive side has four separate parts.

Outer Plate **A**
Inner Plate **B** Direct & none Direct.

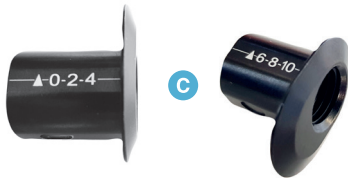

Adjustable End Cap **C** and the Adjustable End Cap security bolt **D**

The Outer plate can be moved forward and backwards on the Inner Plate, to allow for the adjustment of the rear wheel in the frame.

⚠ 5mm minimum wheel clearance to rear of the seat tube.



You must always locate the Outer Plate in the grooves in the Inner Plate. The Outer Plate can be rotated 180 degree to accommodate a range from 0 to 10 mm.

The Adjustable End Cap must also be rotated to match the number on the outer Plate, top side.

Then secured in place with the Adjustable End Cap security bolt.

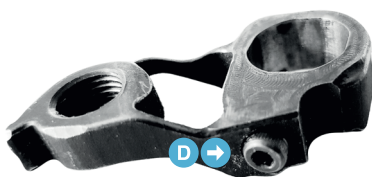

⚠ Torques for dropout bolts **E** and **F**: 3 Nm For **D** 1Nm

▶ Continued



The left none drive side dropout can be moved inline with the right side by adjusting bolt **G** and sliding the complete unit backwards or forwards

⚠ Adjust the right side dropout before the left.

⚠ Torque for Bolt **G** is: 10 Nm



⚠ Rear Through Axle tighten to 12 Nm

The Front Derailleur has two mounting plates, one for a double crankset and one blank for a single chainring crankset.

A full set of hose guide rubbers are available aftermarket if required.

► Continued

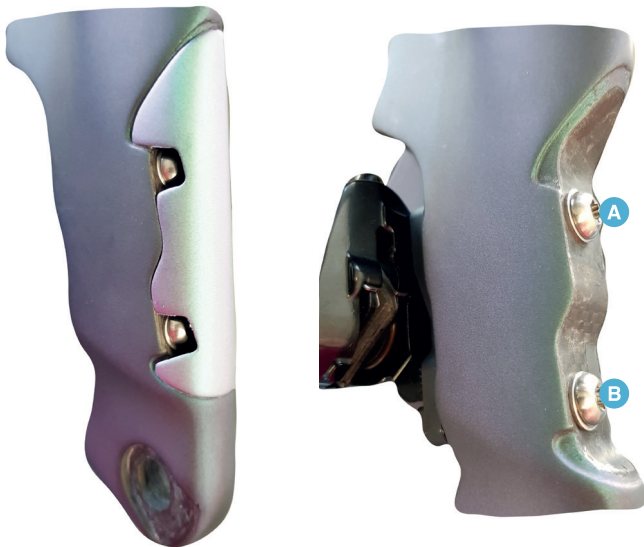

The Front Brake Cover will be magnetic, the same concept as the Addict RC.

Available aftermarket.

The mounting bolts for the front brake are a set sizes.

The Top Bolt **A** is longer than the Bottom Bolt **B**.

⚠ Bolt **A** is a specific bolt for Shimano Front Brakes

(SM-MA Converter Y81743350). **B** standard Shimano Bolt 43mm with security nose.

⚠ For Sram Front Brakes the standard Sram bolts are ok

A 42mm, **B** 37mm. Both with washers.

⚠ Torque for both bolts: 6Nm



⚠ Front Axle Torque 12Nm

► Seatpost Clamp and Saddle Clamp

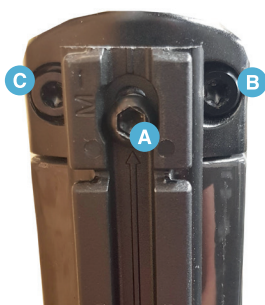

To adjust the seatpost clamp you do not need to remove the rear Storage box assembly plate.

(**A**) ⚠ Tightening Torque 3Nm

⚠ The seatpost clamp bolts **B** and **C** to be tightened to 5Nm



The saddle rail clamp will be the Standard Ritchey WCS system.

Clamp sizes available in 7 x7, 7x9.6, and 8x8.5.

All available after market from your Ritchey Supplier.

► Hydration System

The Plasma 6 has a five section storage and hydration system.

Drinking Fluids can be stored either in the integrated top tube Hydration bottle. Or low down above the bottom bracket in the Gel Bottle.

Storage is either behind the seat tube or between the handlebar extensions.

All storage and drink systems will be within a frame size specific. Please check with your Authorised Scott Dealer if you need to replace any parts.



The Gel Bottle can be released from the frame by pressing points **A** on both side of the frame.

Points **B** and **C** are removable. Point **B** is a cover from the frame and Point **C** is the mouth piece where you can fill the bottle (removable).

If you wish to use a bottle cage on the downtube, be aware that the access to your Gel Bottle will be impaired.





The Storage Box behind the seat tube can be accessed by pressing points **A** on the lid both sides (lid not pictured).

You can release the box from the mounting by pulling gently point **B** and sliding upwards as indicated by point **C**.

▶ Continued



The Top Tube Hydration Bottle can be released from the frame by pressing  gently.

First lift the front of the bottle and then the rear as indicated below,  and .

The rear of the bottle is clipped into place by a small retainer.

To refit, reverse the procedure above.



The Hydration Bottle can be refill whilst in place by lifting the small cap marked .



The Nutrition Box between the handlebar extensions can be tilt downwards so you can attached a larger GPS unit.

On the underside of the Nutrition Box you will have a key which will unlock the box.

Clockwise to release, Anti Clockwise to tighten.

 If you have a Sram BlipBox situated inside the Nutrition Box make sure not to damage the cables when moving the box Downwards.



The Nutrition Box can also be adjusted upwards and downwards via a screw on the inside of the Nutrition Box.

▶ Continued

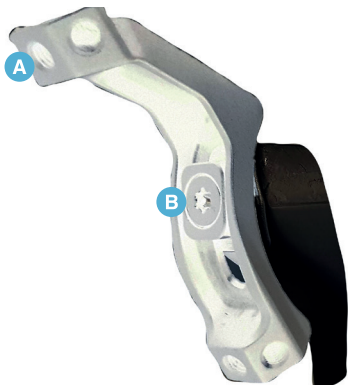

There is also an additional double bottle cage mount for the rear of the seatpost.

⚠ Tighten Torque for **A** 3Nm and **B** 5Nm

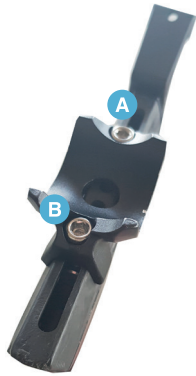

The seatpost bottle cage mount can be positioned to accommodate large drink bottles.

The full assembly can move backwards & forwards within a limited range depending on your saddle position.

A & **B** can be loosened to allow the movement of the inner seatpost plate backwards & forwards.

⚠ Tightening torque for these bolts 5Nm



When the saddle clamp base plate is pushed all the way forward you cannot extend the plate.

If the saddle clamp base plate is in the middle or to the rear you will have some additional extension available.



Please make sure you always have your saddle within the limiter marks on the saddle rails.

► GUARANTEE ON SCOTT BIKES

What is covered?

This warranty covers defects in materials and workmanship at the time of transfer of risks in frames, swingarms and forks (provided it is a SCOTT fork) on SCOTT branded bikes sold completely assembled by SCOTT or an authorized SCOTT dealer ("Product").

How long does coverage last?

This voluntary manufacturer's warranty is limited to five years for frames and swingarms, respectively two years for forks, from the date of purchase of the Product and is limited to the first purchaser of the Product and subject to the prior registration of your SCOTT bike on www.scott-sports.com within 10 days as of the date of purchase.

Transfer of the Product from the first purchaser to another person terminates this limited warranty.

The limited warranty of five years for the frames and swingarms shall only be granted in a maintenance service has been effected case once a year according to maintenance requirements as set forth in the manual. The effected annual maintenance service shall be confirmed by stamp and signature. In case such an annual maintenance service has not been effected the warranty of five years for the frame shall be reduced to three years. Costs for maintenance and service have to be borne by the owner of the Product.

On Gambler, Voltage Fr and Volt-X the warranty period is limited to two years.

Repaired or replaced Products are covered for the remainder of the original warranty period and subject to the conditions outlined in the original warranty, to the extent permitted by law.

Hereby SCOTT grants a worldwide voluntarily manufacturer's warranty. To the extent permitted by law and unless a shorter duration is stipulated by law, any warranties implied by law are limited in duration to maximum five, respectively two years, from the date of purchase of the Product and are limited to the first purchaser of the Product.

What will SCOTT do in the event of a guarantee case?

SCOTT will replace the defective product with a product of a quality or nature and similar level, will repair or refund the purchase price (after presentation of the proof of purchase of the product), in its sole discretion. Non-defective components are replaced at your expense. In such a case, we will contact you before replacing the non-defective part for your agreement.

What does this limited warranty not cover?

This limited warranty does not cover defects which did not exist before the transfer of risks. This limited warranty does not cover Products used in rental operations. This limited warranty does not cover purchases of not completely assembled bikes.

This limited warranty does not cover any defect caused by "wear and tear" (a complete list of all parts of "wear and tear" can be found in the manual), accident, neglect, improper handling, colour fade due to exposure to sunlight, abuse, misuse, an act of God, improper assembly, non-compliance with recommended maintenance and care procedures, improper or incorrectly performed maintenance or repairs performed by someone other than an authorized SCOTT dealer, use of parts or devices not consistent with the Product, and alteration of the Product. All Products come with a manual; please carefully follow the instructions located there or affixed elsewhere to the Product. To the extent permitted by law, consequential and incidental damages are not recoverable under this limited warranty.

How do you make a claim under this limited warranty?

To make a claim under this limited warranty, you must notify SCOTT of the claimed defect within the warranty period and timely return the Product to SCOTT at your expense for inspection. Please contact your authorized SCOTT dealer, call SCOTT's customer service or the national SCOTT distributor (dealer locator: www.scott-sports.com). All returned Products must be accompanied by proof of purchase (receipt) from an authorized SCOTT dealer or this limited warranty will not apply. In case of replacement or refund, the returned Product becomes the property of SCOTT.

A protocol for the handing over of the Product (which you will find at the end of the manual) will remain in copy at the SCOTT dealer after acceptance and signature of the consumer. It is obligatory to show this protocol of handing over together with the defective part in case of a warranty claim given that it provides evidence of purchase or this limited warranty will not apply.

How do state laws affect your rights under this limited warranty?

This limited warranty gives you specific legal rights, and you may also have other rights, which vary from state to state.

Recommendation:

We strongly recommend that you use only authorized SCOTT dealers for yearly maintenance services and for repairs, as improper or incorrectly performed maintenance or repairs voids this limited warranty. Costs for maintenance service have to be borne by the consumer.

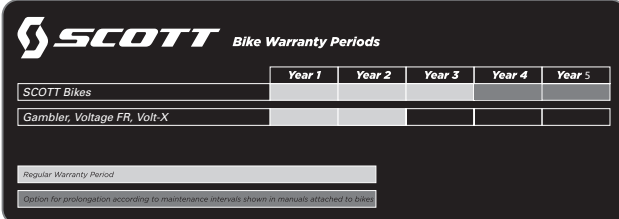

	Year 1	Year 2	Year 3	Year 4	Year 5
SCOTT Bikes					
Gambler, Voltage FR, Volt-X					
Regular Warranty Period					
Option for prolongation according to maintenance intervals shown in manuals attached to bikes					



© SCOTT Sports SA 2021. All rights reserved. v1.1/05/01/21
The information contained in this manual is in various languages but only the English version
will be relevant in case of conflict.

P.E.D Zone C1, Rue Du Kiell 60 | 6790 Aubange | Belgium Distribution: SSG (Europe) Distribution Center SA SCOTT Sports SA | 11 Route du Crochet | 1762 Givisiez |
2020 SCOTT Sports SA www.scott-sports.com Email: webmaster.marketing@scott-sports.com