



**SCOTT**

# ADDICT GRAVEL MANUAL



# Geometry & Technical Data:

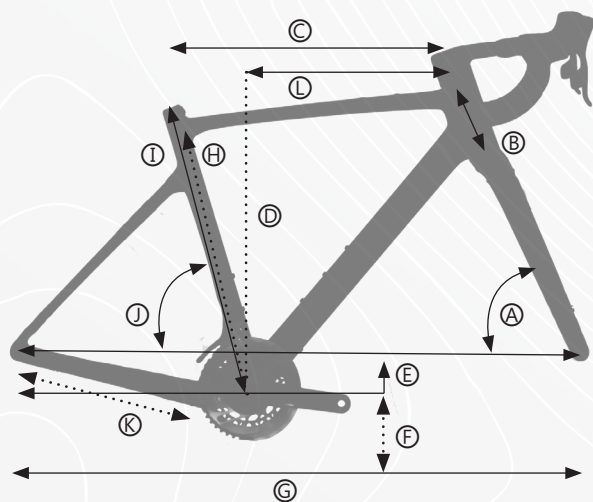

Seatpost:	Addict Aero
Seatpost Clamp:	Addict Aero
Fork Steerer:	1 1/4 - 1 1/2
Headset:	IS52 /31,8 - IS 52/40
Rear Axle:	142mm
Front Axle:	100mm
BB Housing:	41x86.5mm
Max/Min Front Rotor:	180/160mm
Max/Min Rear Rotor:	160/140mm
Tyre Width Max:	45mm



For full installation, please only take your bike to an Authorised Scott Dealer for assistance.



Tyre sizes often vary from brand to brand. Always ensure the frame, & fork tyre clearance is adequate when replacing the tyres.

## MY22 ADDICT GRAVEL

	XSmall	Small	Medium	Large	X/Large
A head tube angle	70°	70°	71°	71°	71°
B head tube length	95 mm	122 mm	140 mm	166 mm	187 mm
C top tube horizontal	518 mm	534.5 mm	554.5 mm	578.5 mm	592.5 mm
D standover height	759 mm	786 mm	807 mm	828 mm	847 mm
E BB offset	-71 mm	-71 mm	-71 mm	-71 mm	-71 mm
F BB height	283 mm	283 mm	283 mm	283 mm	283 mm
G wheel base	1009.4 mm	1022.9 mm	1029.2 mm	1048.7 mm	1063.5 mm
H BB center to toptube center	447 mm	477 mm	498 mm	516 mm	536 mm
I BB center to top of seattube	477 mm	507 mm	528 mm	546 mm	566 mm
J seat angle	74.5°	74°	73.5°	73°	73°
K chainstay	425 mm	425 mm	425 mm	425 mm	425 mm
L reach	374.1 mm	378.4 mm	387.1 mm	398.2 mm	406.1 mm
stack	519 mm	544.4 mm	565.3 mm	589.9 mm	609.7 mm
Trail	75.6 mm	75.6 mm	69 mm	69 mm	69 mm
Fork Rake	50 mm	50 mm	50 mm	50 mm	50 mm

## Axles & Dropouts:

The new Addict Gravel will have same dropout as the Addict RC and the rest of the Addict family. The Hanger comes in standard and DM options and includes dropout, threaded axle cap, and fixation bolt.

**277544 SCO Dropout Addict RC 20**

**277545 SCO Dropout Addict RC direct mount 20**

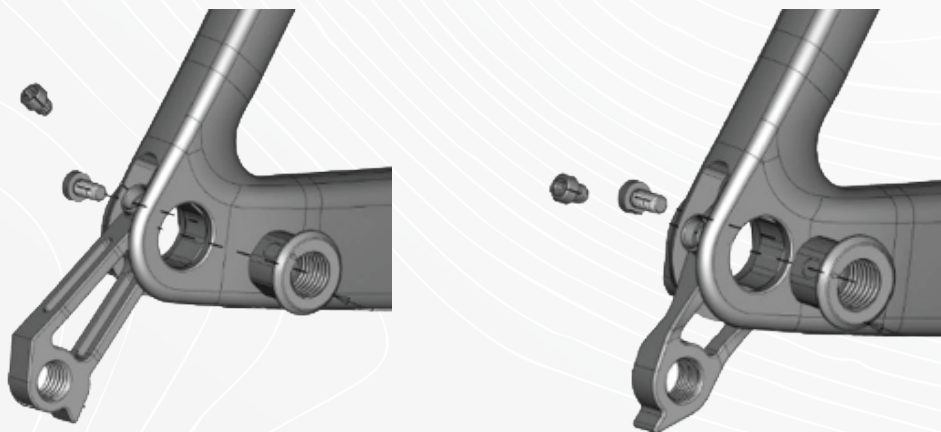

Front and rear axles are available in two variations;

Standard version:

**283340 SCO Axle Foil/Addict/Speedster D R 21**

**283341 SCO Axle Foil/Addict/Speedster D F 21**

Tapered version:

**277029 SCO Axle rear Addict RC/Plasma 6 TP 20**

**277030 SCO Axle rear Addict RC/Plasma 6 20**

## Seatclamp:

The Addict Gravel will share the D-shaped Syncros Duncan Aero SL seatposts and seatclamp from the Addict RC.

**277543 SCO Seatclamp Addict RC 20**

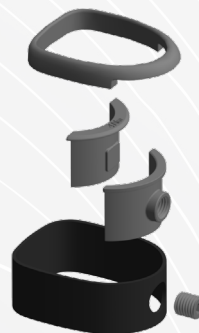

## Cockpit:

The new Addict Gravel will have fully integrated cable routing through the stem and headset, with a gravel specific handlebar from Syncros with 16-degree flare and shorter reach.

The Addict Gravel will have two different stem/handlebar options depending on the bike model.

### **288087, 288088, 288089, 288090, and Creston iC SL X 288123 SYN Stem RR 2.0**

The Addict Gravel will use the same headset kit for both Creston iC SL X combo and the RR2.0/RR2.5 stem.

### **288249 SYN Headset IS52/31.8 - IS52/42**



There will be two headset spacer kits, one kit for the Creston iC SL X combo and one kit for RR2.0/RR2.5 stem.



**277547 SCO Stem  
spacer kit SY Crest iC**

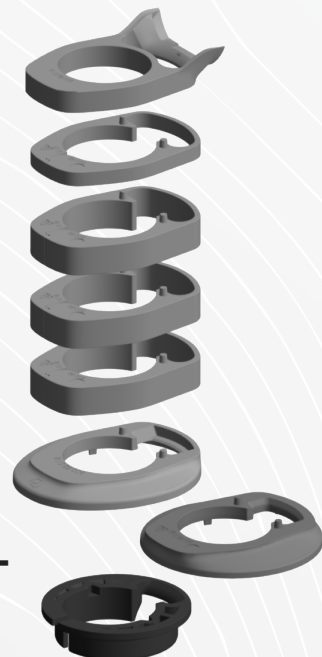

**290055 SCO Headset  
spacer kit Add-Speed-  
Grav 22**

### **294283 SCO Stem cable cover Speed/Addict 22**

The Stem Cable Cover is size specific to the RR2.0/2.5 stem.



XXS: 83 mm  
XS: 93 mm  
Small: 103 mm  
Medium/Large: 113 mm  
XL/XXL: 123mm

### **277550 SCO Stem steerer cap SY Crest iC**

Creston iC SL X will use the same Stem cap as Addict RC Creston Handlebars, not size specific.

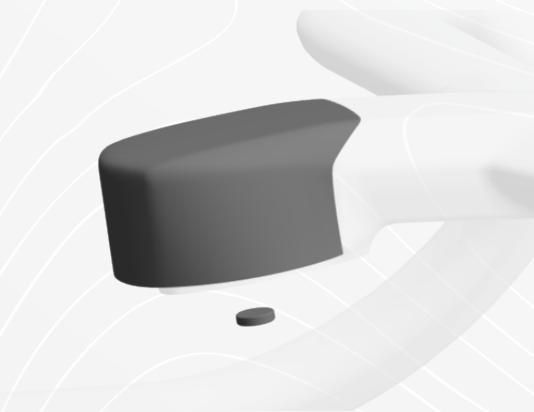

### **275472 SCO Stem hardware kit Fras iC, Crest iC**

You will be able fit the Addict RC IC CRESTON and RR1.5 Stems and Handlebars to the MY22 Addict Gravel if the correct spacer kit is fitted.

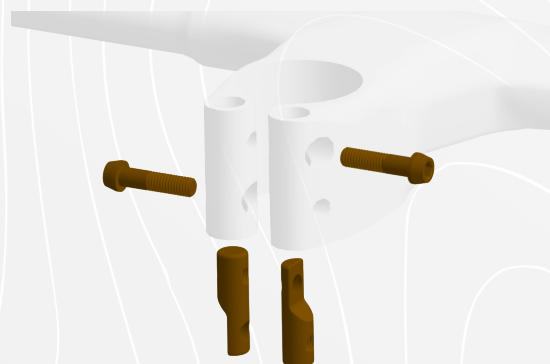

## FD / Chainguide:

### **290023 SCO FD kit Addict Gravel 22**

Includes chainguide, FD mount and FD cable guide blanks



## Cable Guides & Protection Kits:

The new Addict Gravel has several mounts for fitting of bags, fenders, and extra bottle cages.

The following kit contains the cable guides and blanks for the different frame and fender mounts.

### **290022 SCO Cableguide / blank set Addict GR 22**

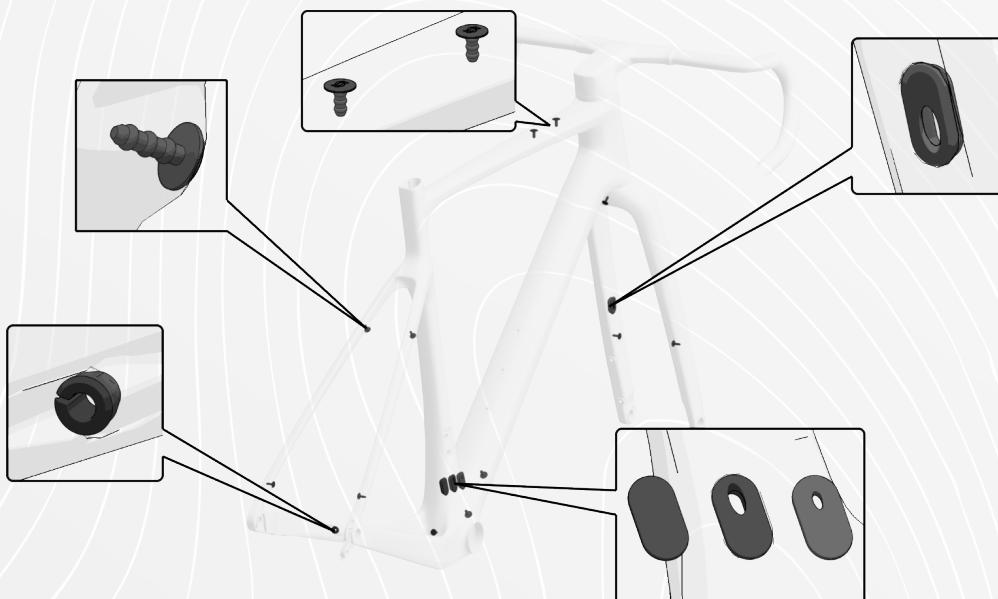

Dedicated fenderset for the Addict Gravel:

### 288344 SYN Road gravel fender set for AL/CB



### 290019 SCO C-Stay protection kit Addict gra 22

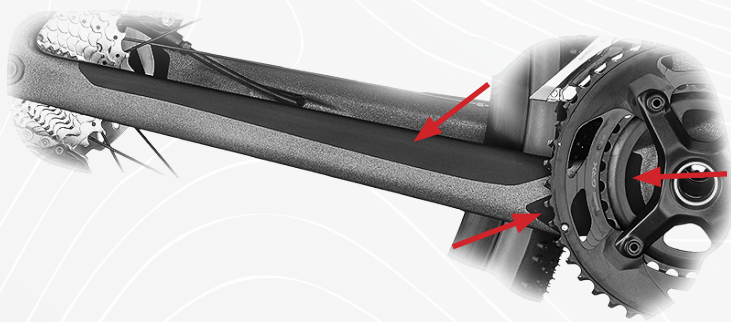

## Cable Routing:

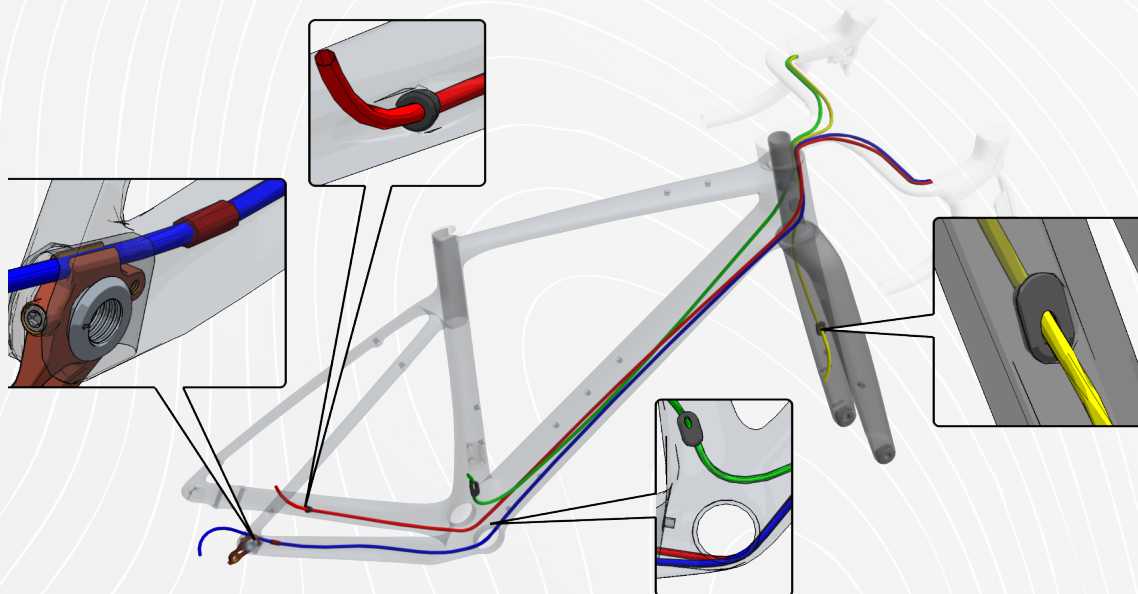

## GUARANTEE ON SCOTT BIKES

### What is covered?

This warranty covers defects in materials and workmanship at the time of transfer of risks in frames, swingarms and forks (provided it is a SCOTT fork) on SCOTT branded bikes sold completely assembled by SCOTT or an authorized SCOTT dealer ("Product").

### How long does coverage last?

This voluntary manufacturer's warranty is limited to five years for frames and swingarms, respectively two years for forks, from the date of purchase of the Product and is limited to the first purchaser of the Product and subject to the prior registration of your SCOTT bike on [www.scott-sports.com](http://www.scott-sports.com) within 10 days as of the date of purchase.

Transfer of the Product from the first purchaser to another person terminates this limited warranty.

The limited warranty of five years for the frames and swingarms shall only be granted in a maintenance service has been effected case once a year according to maintenance requirements as set forth in the manual. The effected annual maintenance service shall be confirmed by stamp and signature. In case such an annual maintenance service has not been effected the warranty of five years for the frame shall be reduced to three years. Costs for maintenance and service have to be borne by the owner of the Product.

On Gambler, Voltage Fr and Volt-X the warranty period is limited to two years.

Repaired or replaced Products are covered for the remainder of the original warranty period and subject to the conditions outlined in the original warranty, to the extent permitted by law.

Hereby SCOTT grants a worldwide voluntarily manufacturer's warranty. To the extent permitted by law and unless a shorter duration is stipulated by law, any warranties implied by law are limited in duration to maximum five, respectively two years, from the date of purchase of the Product and are limited to the first purchaser of the Product.

### What will SCOTT do in the event of a guarantee case?

SCOTT will replace the defective product with a product of a quality or nature and similar level, will repair or refund the purchase price (after presentation of the proof of purchase of the product), in its sole discretion. Non-defective components are replaced at your expense. In such a case, we will contact you before replacing the non-defective part for your agreement.

### What does this limited warranty not cover?

This limited warranty does not cover defects which did not exist before the transfer of risks. This limited warranty does not cover Products used in rental operations. This limited warranty does not cover purchases of not completely assembled bikes.

This limited warranty does not cover any defect caused by "wear and tear" (a complete list of all parts of "wear and tear" can be found in the manual), accident, neglect, improper handling, colour fade due to exposure to sunlight, abuse, misuse, an act of God, improper assembly, non-compliance with recommended maintenance and care procedures, improper or incorrectly performed maintenance or repairs performed by someone other than an authorized SCOTT dealer, use of parts or devices not consistent with the Product, and

alteration of the Product. All Products come with a manual; please carefully follow the instructions located there or affixed elsewhere to the Product. To the extent permitted by law, consequential and incidental damages are not recoverable under this limited warranty.

### How do you make a claim under this limited warranty?

To make a claim under this limited warranty, you must notify SCOTT of the claimed defect within the warranty period and timely return the Product to SCOTT at your expense for inspection. Please contact your authorized SCOTT dealer, call SCOTT's customer service or the national SCOTT distributor (dealer locator: [www.scott-sports.com](http://www.scott-sports.com)). All returned Products must be accompanied by proof of purchase (receipt) from an authorized SCOTT dealer or this limited warranty will not apply. In case of replacement or refund, the returned Product becomes the property of SCOTT.

A protocol for the handing over of the Product (which you will find at the end of the manual) will remain in copy at the SCOTT dealer after acceptance and signature of the consumer. It is obligatory to show this protocol of handing over together with the defective part in case of a warranty claim given that it provides evidence of purchase or this limited warranty will not apply.

### How do state laws affect your rights under this limited warranty?

This limited warranty gives you specific legal rights, and you may also have other rights, which vary from state to state.

### Recommendation:

We strongly recommend that you use only authorized SCOTT dealers for yearly maintenance services and for repairs, as improper or incorrectly performed maintenance or repairs voids this limited warranty. Costs for maintenance service have to be borne by the consumer.

SCOTT Bike Warranty Periods					
	Year 1	Year 2	Year 3	Year 4	Year 5
SCOTT Bikes					
Gambler, Voltage FR, Volt-X					
Regular Warranty Period					
Option for prolongation according to maintenance intervals shown in manuals attached to bikes					





All rights reserved ©2021 SCOTT Sports SA

---

#### ILLUSTRATIONS

Background Designed by starline / Freepik/Vecteezy.com

---

The information contained in this techbook is in various languages but only the English version will be relevant in case of conflict.  
Although SCOTT Sports SA has published all information contained in this techbook after careful examination, SCOTT Sports SA assumes no liability for being up-to-date, correct, reliable or complete. SCOTT Sports SA reserves the right to change the content of this techbook, particularly colors, materials and specifications, at any time without prior notice. Any liability shall be exempted.  
Products shown may not be available in all regions, please check with your local SCOTT retailer for availability.

---

#### EDITOR

SCOTT SPORTS SA  
Route du Crochet 11  
1762 Givisiez  
Switzerland

Authorized Representative: Beat Zaugg, Pascal Ducrot

Tel: +41 (0)26 460 16 16  
Fax: +41 (0)26 460 16 00  
webmaster.marketing@scott-sports.com  
**www.scott-sports.com**

Commercial register: Fribourg  
Register number: CH-217-0135214-3  
VAT-ID: CH466324

