



2023 SCOTT
FOIL RC
MANUAL



CONTENT

THE FOIL RC SHOULD BE ADJUSTED EXACTLY TO THE RIDER FOR MAXIMUM SAFETY AND RIDEABILITY.

Please contact your authorized SCOTT dealer for advice in order to avoid technical problems or any harm.

GEOMETRY & TECHNICAL DATA	03
SEAT CLAMP ADJUSTMENT	04
SEATPOST ASSEMBLY FOR DUNCAN SL AERO & AERO COMFORT	06
CABLE ROUTING	07
SPARE PARTS	08
MANUFACTURE'S GUARANTEE	11

LEGEND



TORQUE REQUIRED



TORX TOOL SIZE



NO GREASE REQUIRED



TORQUE AMOUNT



GREASE REQUIRED



TASK DIFFICULTY



CARBON GREASE REQUIRED



HEX TOOL SIZE



THREADLOC REQUIRED



BEARING FIT REQUIRED

GEOMETRY & TECHNICAL DATA

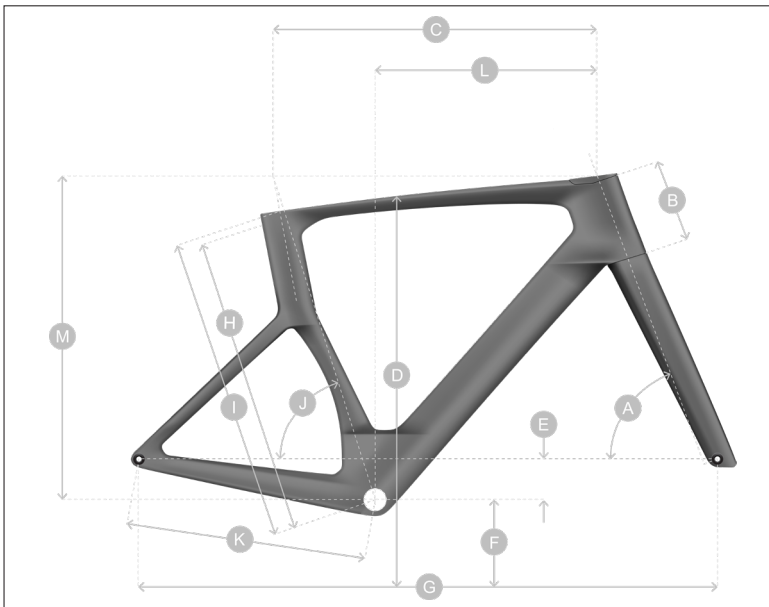
**Max/Min Rotor Size:**

Front Max/Min 180mm / 160mm

Rear Max/Min 160mm / 140mm

Headset:

Top: 44x35x5.5 / 36°-45°

Bottom: 40x52x7 / 45° - 45°

Max Tyre Size:

30mm

BB Housing:

41 x 86.5mm

Fork Steerer:

1 - 1 1/2 inch

Axle Dimensions:

Front: 100mm Rear: 142mm

	MY22 FOIL RC		47 XXS	49XS	52 S	54 M	56 LG	58 XL	61 XXL
A	Head tube angle	°	70.5	71	72	72.5	73	73.3	73.3
B	Head tube length	mm	103	108	121	141	161	181	199
C	Top tube horizontal	mm	520	530	540	550	565	580	600
D	standover height	mm	746.4	759.6	779.4	801	820	838	853.3
E	BB offset	mm	-70	-70	-70	-70	-70	-70	-70
F	BB height	mm	274.5	274.5	274.5	274.5	274.5	274.5	274.5
G	Wheelbase	mm	987.7	993.7	990.7	992.6	999.9	1008.6	1022.7
H	BB center to TTC	mm	450.8	480.9	501.4	521.6	541.4	558.8	571.4
I	BB center to TST	mm	451.8	481.9	502.4	522.6	542.4	559.8	572.4
J	Seat angle	°	74.5	74.5	74	73.6	73.3	73	72.5
K	Chainstay	mm	412	412	412	412	412	412	412
L	Reach	mm	380	388	389	389	394.5	400	409
M	Stack	mm	505	511	527	548	568	589	606
	Fork Rake	mm	45	45	45	45	45	45	45
	Trail	mm	73.5	70.3	64	60.8	57.7	55.8	55.8

FOIL RC

SADDLE CLAMP ADJUSTMENT



01

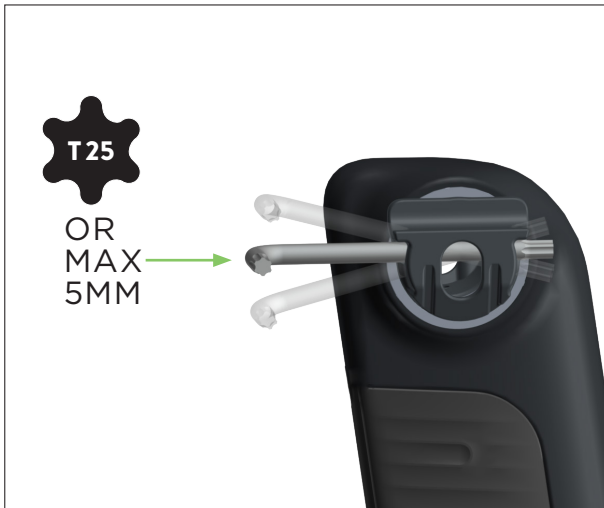

02

03

04

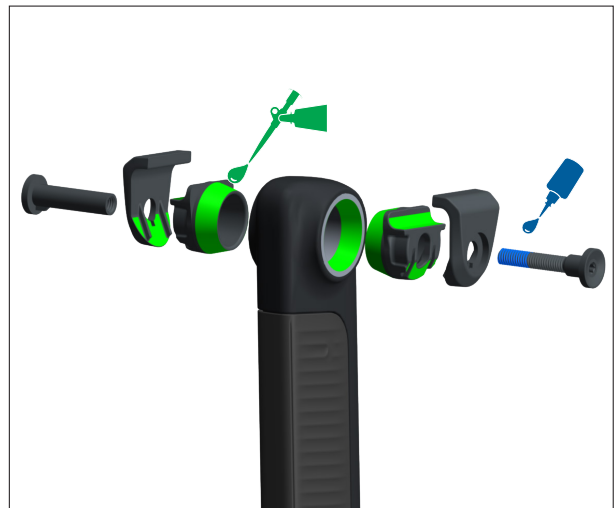
FOIL RC

SADDLE CLAMP ADJUSTMENT *CONTINUED



05



06



07
 

FOIL RC

SEATPOST ASSEMBLY FOR DUNCAN SL AERO & AERO COMFORT



01 MOLYKOTE 111
 1000 KMS
 * Duncan SL Aero Comfort



02 Carbon Grease
 * Duncan SL Aero Comfort & Duncan SL Aero

- 292895 SYN S.post Duncan SL Aero CFT, 0mm**
- 292896 SYN S.post Duncan SL Aero CFT, 15mm**
- 292893 SYN S.post Duncan SL Aero, 0mm**
- 292894 SYN S.post Duncan SL Aero, 15mm**



For XXS, XS, and Small sized frames the seatpost may need to be cut down in length to accommodate the rider's leg length and position.

Please contact your authorized Scott Dealer for assistance as you could damage your frame if carried out incorrectly.

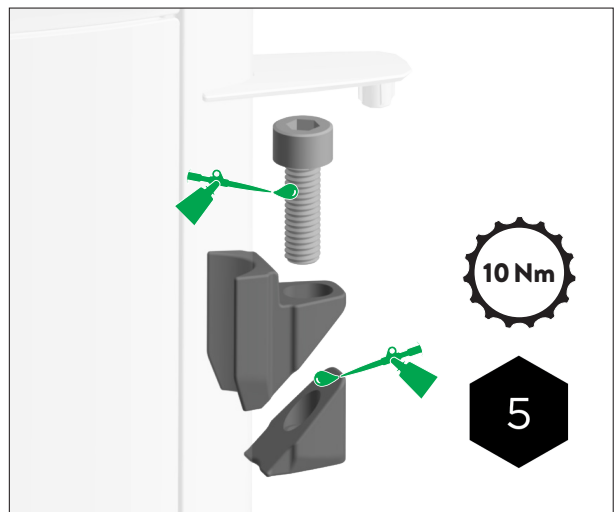

03

FOIL RC

CABLE ROUTING

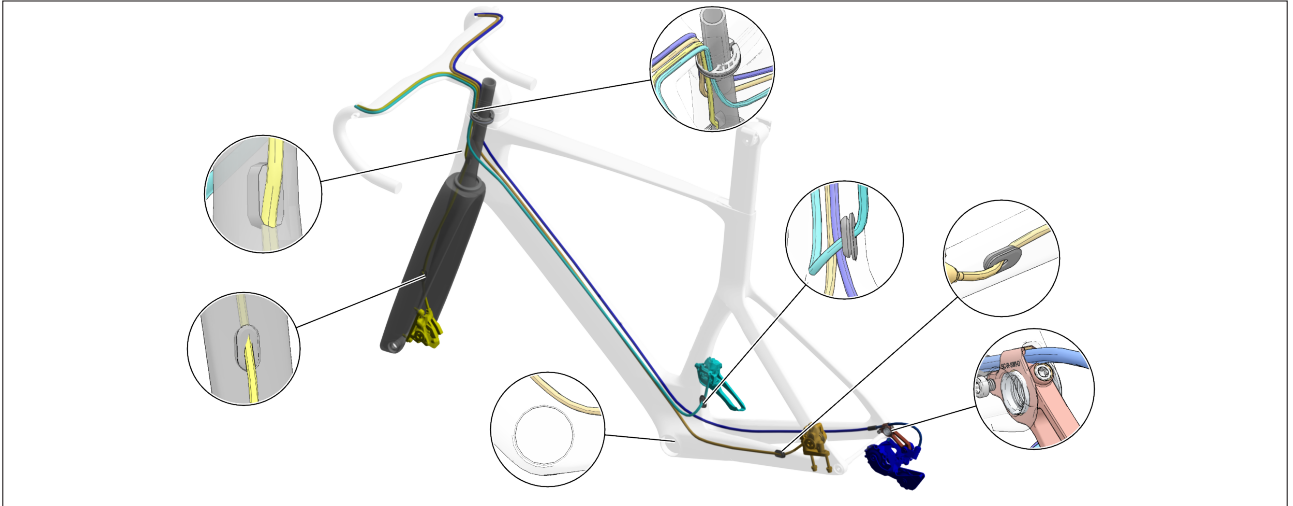

Mechanical Cable and Brake Hose routing.

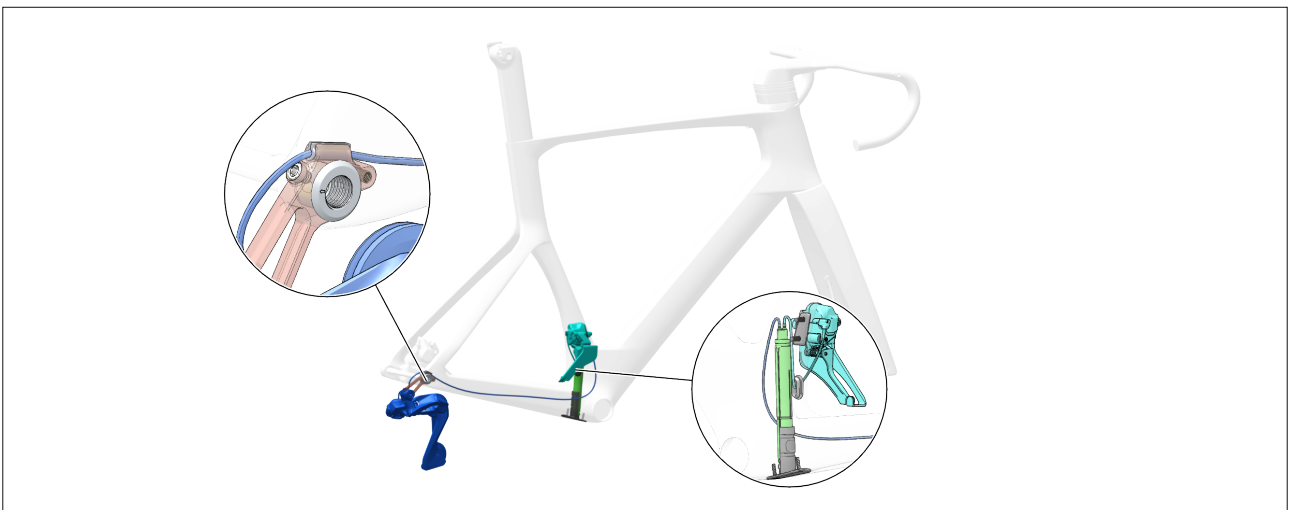

Di2 Wire Routing.

FOIL RC

SPARE PARTS



297731 SCO Axle Foil 3/Plasma 7 F 23

297732 SCO Axle Foil 3/Plasma 7 R 23

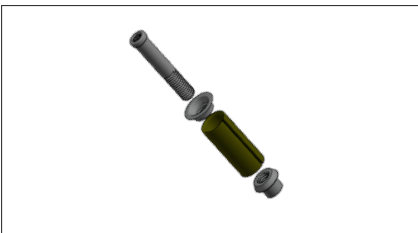

296234 SCO Headset expander Foil 23



296236 SCO Stem hardware kit Creston IC Aero 23



297669 SCO Headset top cap Foil 23



296233 SCO Headset Spacer Creston IC Aero 23

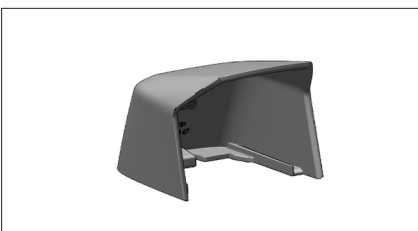

296235 SCO Stem steerer cap Creston IC Aero 23

FOIL RC

SPARE PARTS

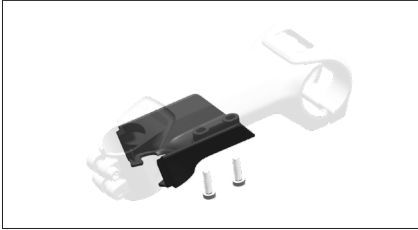

**296237 SCO Stem
Hardware Kit Creston
Ic Aero 23**

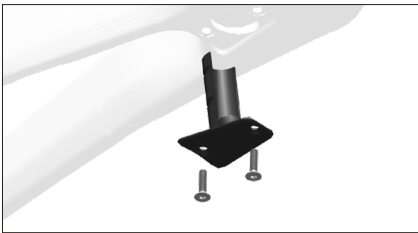

**296242 SCO BB D12
battery mount Foil 23**



**296240 SCO Seatpost
saddle clamp kit Foil 23**

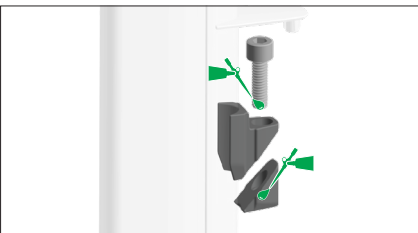
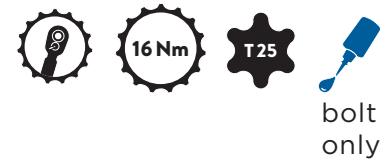

**296239 SCO Seatpost
clamp Foil 23**



**296241 SCO Seatpost
rubber cover Foil 23**



**296238 SCO Bar
Rubber Creston 1.0
Aero 23**

FOIL RC

SPARE PARTS

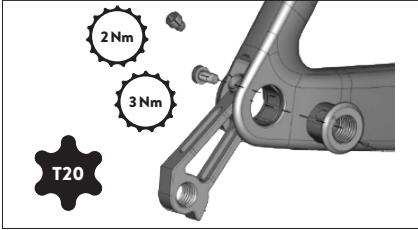

296605 SCO Dropout Foil /Plasma DM 23
277544 SCO Dropout Addict RC 20

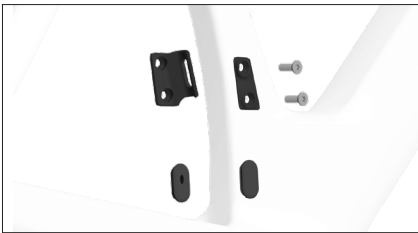

**296243 SCO FD-Mount
and blank Foil 23**



MANUFACTURER'S GUARANTEE,

When purchasing a new SCOTT bicycle from an authorized SCOTT dealer, SCOTT grants a manufacturer's guarantee subject to the following provisions.

CONDITIONS

The manufacturer's guarantee is only granted to the first-time buyer of a SCOTT bicycle who has purchased it from an authorized SCOTT dealer. The manufacturer's guarantee only applies if the bicycle is registered to the first buyer at www.scott-sports.com within ten days of purchase.

DURATION

The manufacturer's guarantee is granted from the date of purchase for a period of five years on bicycle frames and rear ends. The guarantee period is reduced to three years, if the SCOTT bicycle is not serviced at least once a year by an authorized SCOTT dealer. Maintenance services must be carried out in accordance with the maintenance instructions in the SCOTT manual and must be confirmed there by the stamp and signature of the authorized SCOTT dealer.

For frames and rear ends of Category 5 bicycle models and for rigid forks manufactured by SCOTT, the duration of the manufacturer's guarantee is limited to two years.

If a defect on the SCOTT bicycle is remedied within the scope of a manufacturer's guarantee or a warranty claim, the duration of the manufacturer's guarantee is not extended. The manufacturer's guarantee ends, when the first-time buyer transfers ownership of the SCOTT bicycle to a third person.

ASSERTION

The manufacturer's guarantee is provided by SCOTT Sports SA, Route du Crochet 11, 1762 Givisiez, Switzerland. The buyer must inspect the SCOTT bicycle immediately after purchase and notify his authorized SCOTT dealer at once in writing of any obvious defects. Hidden defects must be reported immediately after their discovery. In the event of a guarantee claim, the SCOTT bicycle must be handed over to an authorized SCOTT dealer. The latter will contact SCOTT to remedy the defect. The assertion of a guarantee claim always requires the presentation of the original proof of purchase as well as the proof of maintenance service in the SCOTT manual.

Performance of SCOTT in the event of a guarantee claim

In the event of a guarantee claim, SCOTT will, at its own discretion, repair the defect or replace the defective product with a product of similar quality, whereby colour and model deviations are possible. If a repair or replacement is not possible, a purchase price refund will be made taking into account previous use. SCOTT is entitled to commission third parties to remedy the defect.

LIMITATIONS

The manufacturer's guarantee applies exclusively to frames, swingarms and rigid forks of SCOTT bicycles. Bicycle components are excluded from this manufacturer's guarantee.

The manufacturer's guarantee does not apply to normal wear and tear, damage caused by accidents or other excessive force on the SCOTT bicycle, corrosion, improper maintenance, incorrect assembly and assembly of unsuitable components or accessories as well as cosmetic defects, for example in the varnish.

The manufacturer's guarantee does not apply to SCOTT bicycles that have been used in a rental shop.

MISCELLANEOUS

These manufacturer's guarantee provisions apply to all SCOTT bicycles as of model year 2023. Statutory warranty rights of the buyer and guarantees of component manufacturers (Shimano, SRAM etc.) remain unaffected by this manufacturer's guarantee.

The place of jurisdiction for all disputes in connection with this manufacturer's guarantee is Freiburg, Switzerland. This manufacturer's guarantee is subject to Swiss law to the exclusion of all legislation that refers to foreign law.

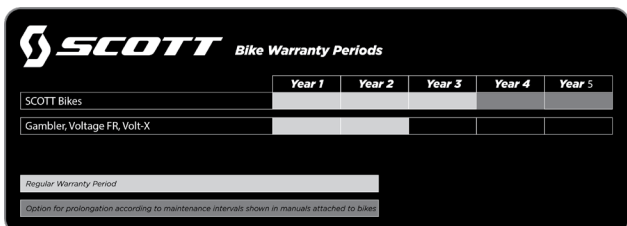

The image shows a 'SCOTT Bike Warranty Periods' table. It has a header row with columns for 'Year 1', 'Year 2', 'Year 3', 'Year 4', and 'Year 5'. Below the header, there are two rows of data. The first row is for 'SCOTT Bikes' and the second row is for 'Gambler, Voltage FR, Volt-X'. Both rows have shaded cells under all five year columns, indicating a 5-year warranty. Below the table, there is a section for 'Regular Warranty Period' with a blank line, and a note: 'Option for prolongation according to maintenance intervals shown in manuals attached to bikes'.

	Year 1	Year 2	Year 3	Year 4	Year 5
SCOTT Bikes					
Gambler, Voltage FR, Volt-X					

Regular Warranty Period _____
Option for prolongation according to maintenance intervals shown in manuals attached to bikes



© SCOTT Sports SA 2022. All rights reserved.
The information contained in this manual is in various languages
but only the English version will be relevant in case of conflict.

P.E.D Zone C1, Rue Du Kiell 60 | 6790 Aubange | Belgium Distribution: SSG (Europe) Distribution Center SA
SCOTT Sports SA | 11 Route du Crochet | 1762 Givisiez | 2022 SCOTT Sports SA www.scott-sports.com Email:
webmaster.marketing@scott-sports.com