



OWNER'S MANUAL YETI SB150

TABLE OF CONTENTS

BRAND OVERVIEW	06
FRAME FEATURES	08
GEOMETRY	10
MAINTENANCE SCHEDULE	12
<i>SETUP</i>	
OVERVIEW	13
<i>TECHNICAL</i>	
ASSEMBLY OVERVIEW	14
EXPLODED VIEWS	26
REBUILD KITS	28
<i>LEGAL</i>	
WARRANTY	32
CONTACT INFORMATION	33

CONGRATULATIONS ON YOUR PURCHASE OF A NEW YETI. WELCOME TO THE TRIBE.

We are confident your new bicycle will exceed your expectations for value, performance, and ride quality. Each frameset and component has been custom specified and designed to enhance your riding experience. Whether you are a beginner cyclist, or a seasoned pro, your Yeti bicycle will provide endless hours of two-wheeled fun.

This model specific manual is designed to be used in conjunction with the general Yeti Owner's Manual and the manuals supplied by the suspension manufacturers. If you did not receive the Yeti owner's manual or the manual provided by the suspension manufacturer download the materials off the Internet, or contact your local dealer.

Bicycling can be a hazardous activity even under the best of circumstances. Proper maintenance of your bicycle is your responsibility and when done properly helps reduce the risk of injury and damage to your bicycle.

Warning: Make sure you review and understand the warnings, instructions, and content of this manual and accompanying manuals for your bicycle.

Warning: Technological advances have made bicycles and bicycle components more complex and the pace of innovation is increasing. It is impossible for this manual or the accompanying manuals to provide all the information required to properly repair and/or maintain your bicycle. In order to help minimize the chances of an injury, it is critical for you to have work performed by an authorized Yeti retailer.

This manual outlines basic setup and maintenance recommendations of your new Yeti. Because it is impossible to anticipate every situation or condition that may occur during the assembly, setup, and maintenance of your bicycle, Yeti recommends that all service and repairs be performed by your local authorized Yeti Dealer.

This manual contains many "Warnings" and "Cautions" concerning the consequences of failure to maintain or inspect your bicycle. The word "Warning" indicates a potentially hazardous situation in which, if not avoided, could result in serious injury or death. The word "Caution" indicates a potentially hazardous situation in which, if not avoided may result in minor injuries or damage to your bicycle or a component of your bicycle. Be sure to read and understand all of the Warnings and Cautions listed in the manual.

THE LOWDOWN ON THE SB150 AND ITS FEATURES.

1. SWITCH INFINITY TECHNOLOGY PATENTED SUSPENSION SYSTEM
2. HIGH MODULUS CARBON FIBER MAIN FRAME AND SWING ARM
3. COLLET AXLE SYSTEM ON PIVOTS REDUCES BEARING WEAR
4. OPTIMIZED FOR 1X DRIVETRAINS ONLY
5. ISCG 05 CHAINGUIDE MOUNTS
6. INTEGRATED HEAD TUBE (41MM/52MM)
7. SUSPENSION BY FOX
8. CUSTOM DEBRIS AND CHAIN SLAP GUARDS
9. INTERNAL CABLE ROUTING
10. INTEGRATED AXLE AND DERAILLEUR HANGER SYSTEM

1. The SB150 delivers 150mm of travel with our patented Switch Infinity Technology. Efficient pedaling performance while still smooth and continuous when the going gets rough.
2. High modulus carbon provides a stiff, strong and light weight chassis.
3. Colleted pivot axles help create a stiff interface between the front and rear triangles of the frame. Custom Enduro Max sealed bearings keep things moving freely at the pivots.
4. The SB150 does away with the front derailleur mount, making it a 1x drive specific frame. This increases stiffness in the frame, making the SB150 one of the stiffest bikes in our lineup.
5. ISCG 05 chain guide mounts are included on the SB150 if case you want to go for some extra drivetrain security in the rowdy sections.
6. Using our integrated head tube on the SB150 allows for a larger head tube with more area, increased stiffness, and lower overall ride height without compromising any performance.
7. The SB150 uses a 230 x 60mm Float X2 shock, by Fox Racing Shox.
8. Custom guards on the seat stay, chain stay and down tube keep things quiet while riding and protect the frame.
9. The SB150 features internal routing for all cables, making the bike quiet and clean looking as well as reducing cable rub on the paint.
10. Dedicated 12 x 148 Boost dropouts and integrated hanger with axle threads for strength, stiffness, ease of hanger and wheel installation.

GEOMETRY

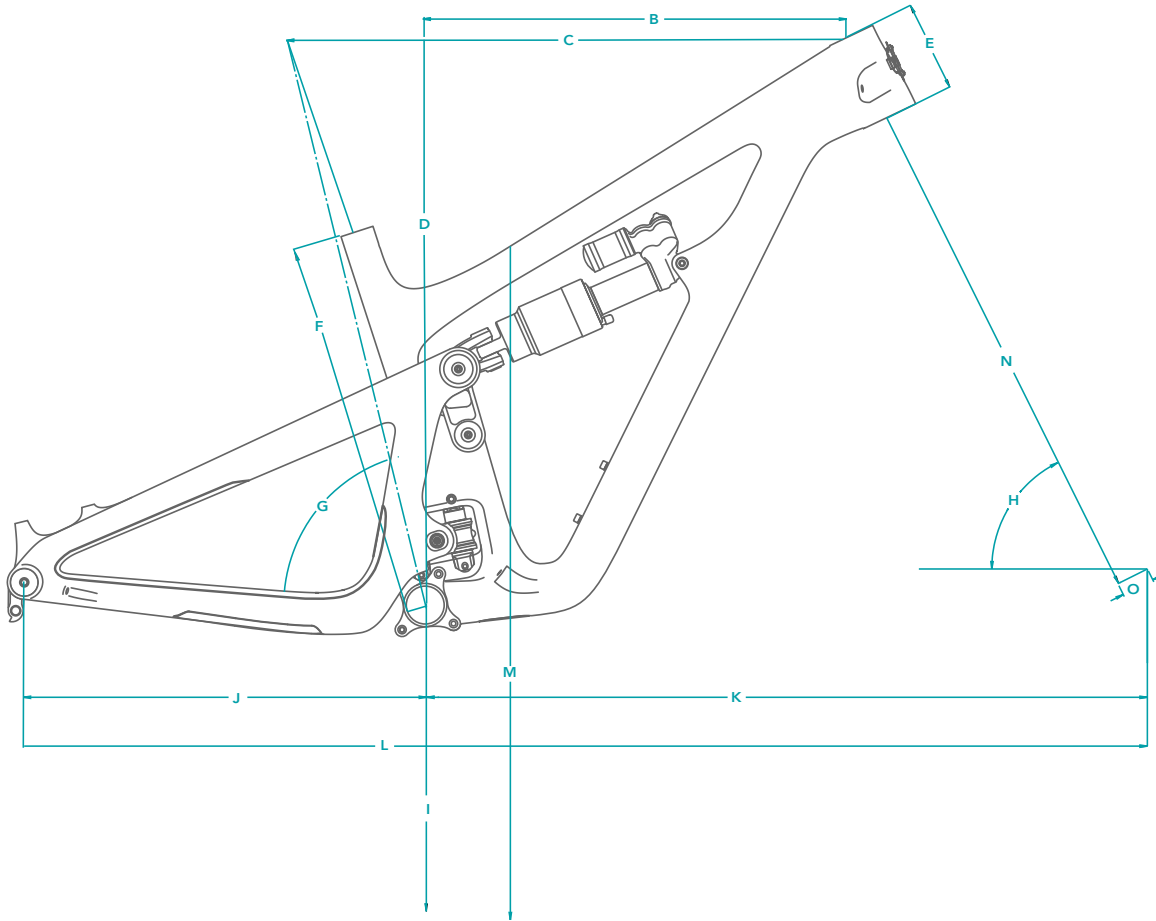

FOX 36 / 170MM FORK

	SM	MD	LG	XL
A WHEEL	29"	29"	29"	29"
B REACH	430.2	460.2	480.2	505.2
C EFF. TOP TUBE	572	602.5	625.7	654
D STACK	613.5	615	625	635
E HEAD TUBE LENGTH	95	96	107.7	118.8
F SEAT TUBE LENGTH	380	410	450	495
G EFF. SEAT TUBE ANGLE	77	77	76.9	76.8
H HEAD TUBE ANGLE	64.5	64.5	64.5	64.5
I EST. BB HEIGHT	348	348	348	348
J CHAINSTAY LENGTH	433	433	433	433
K FRONT-CENTER	758.6	789.3	814.1	843.8
L WHEELBASE	1191.6	1222.3	1247.1	1276.8
M STANDOVER	720.8	728	740.9	761.8
N ALXE TO CROWN	577.1	577.1	577.1	577.1
O FORK OFFSET	44	44	44	44

*All measurements are in millimeters

FIT

SMALL 5'1" (155 CM) - 5'7" (170 CM)

MEDIUM 5'5" (165 CM) - 5'11" (180 CM)

LARGE 5'10" (178 CM) - 6'3" (191 CM)

X-LARGE 6'1" (185 CM) - 6'7" (200 CM)

KEEP YOUR YETI FRESH AND CLEAN

OVERVIEW

Following these guidelines will help maintain the performance of your bicycle and prevent more serious problems from arising. It is important to remember that service intervals can vary depending on climate, trail conditions and riding frequency. If you are unsure about working on your own bicycle, contact your authorized Yeti Dealer for more information on general bicycle maintenance.

SCHEDULE	WEEKLY	MONTHLY	3 MONTHS	ANNUALLY
CLEAN AND LUBE CHAIN	■			
CHECK TIRE PRESSURE	■			
CLEAN BIKE OF MUD AND DEBRIS	■			
CHECK BRAKE FUNCTION	■			
CHECK SHOCK PRESSURE, IF APPLICABLE		■		
CHECK FOR LOOSE BOLTS AND TIGHTEN, IF NECESSARY		■		
CHECK HEADSET AND TIGHTEN / LOOSEN, IF NECESSARY		■		
THOROUGHLY CLEAN PIVOT POINTS WITH A RAG (DO NOT LUBRICATE)		■		
LUBE INFINITY LINK EVERY 40 HRS. (YETI HEAVY MOLYBDENUM GREASE)		■		
CHECK / REPLACE BRAKE PADS, IF NECESSARY			■	
CHECK TIRES FOR WEAR			■	
CHECK SPOKE TENSION AND RETENTION, IF NECESSARY			■	
CHECK CHAIN FOR WEAR AND REPLACE IF NECESSARY			■	
COMPLETE TUNE-UP PERFORMED BY AN AUTHORIZED YETI DEALER				■

TORQUE

Yeti strongly recommends using a torque wrench when assembling your frame. Torque specifications for individual parts on the SB150 are listed below, as well as in the step by step assembly instructions later in the manual. For general bicycle maintenance please consult the torque specifications of the component you are adjusting.

KEY TORQUE SPECS

PART NUMBER	DESCRIPTION	TORQUE (NM)
300040485	MAIN PIVOT AXLE	12
200020327	SS PIVOT BOLT, FEMALE	16
300030296	COLLET AXLE 30.5X10.5 M10X1.0	13
300040486	COLLET WEDGE BOLT, LARGE	14
300030293	LINK, PIVOT HARDWARE, MALE, 15MM	15
300060073	12X148 DERAILLEUR HANGER	10
300030057	SHCS M6x1.0 20L, SWITCH LINK MOUNT	12
300040486	COLLET WEDGE BOLT, SMALL	8
100425006	AXLE, YETI BOLT ON, 12X148MM	12-15
300030151	BOLT, TI MALE, M6 X 12.0 MM	10
200020311	LOCKRING, 6902-2RS	20

SEATPOST CABLE ROUTING

STANDARD SETUP



01.
With a 3mm allen key, remove the lower cable port access cover near the bottom bracket.



02.
Install your seatpost housing into the head tube port, pushing until it exits near the lower cable port access hole.



03.
Use your finger to help push the housing around the bend in the frame up into the seat tube.



04.
While pushing the housing into the head tube port, continue pushing the cable up the seat tube through the access port until the housing exits the seat tube.

PARK TOOL SETUP



01.
Remove the lower cable port access cover with a 3mm allen key.



02.
Drop a Park Tool Router tool down the seat tube until it exits the access port.



03.
Push your seatpost housing into the frame from the headtube port until it exits near the access port.

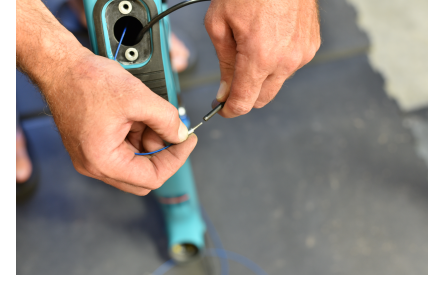

04.
Outside of the access port, connect the Park router tool to the housing.

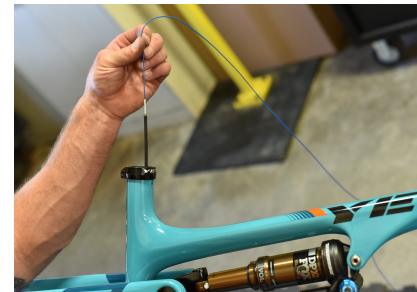

05.
Pull router tool back through the frame until your housing exits the seat tube.

01. HYDRAULIC SETUPS

Route a section of shifter housing through the frame using the steps described in Standard Setups



02.
Connect the double-barb to the shifter housing and the seatpost housing at the seat tube.

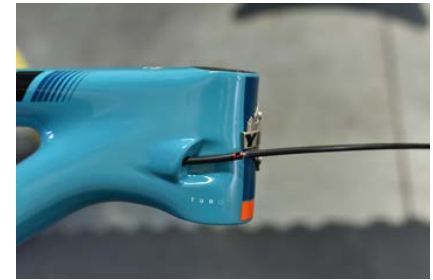

03.
At the same time, pull the shifter housing out of the head tube port while pushing the seatpost housing into the seat tube until the double barb exits the head tube.

BRAKE

Push the brake line into the frame starting at the rear triangle, feeding it forward to the ports into the front triangle and out the head tube.

SHIFTER

Push the shifter housing into the lower head tube port on the non-drive side. Feed the housing back to the ports on the rear triangle and eventually out near the drive-side dropout.

SWITCH INFINITY SERVICE



01.
With a 5mm allen wrench, remove the main pivot Collet Wedge Bolt



02.
With a 10mm allen wrench, remove the Main Pivot Collet Axle. The Collet Nut on the drive side can remain in the frame.



05.
Wipe off any excess grease that was pushed out of the seals.



06.
Lower the swingarm and re-install your Main Pivot Collet Bolt

***Torque 12 Nm**



03.
Rotate your swingarm upwards to access both grease zerks and expose the whole Switch Infinity link. With a clean rag and mild detergent, clean any mud, dust, or debris off the Switch Infinity Link.



04.
Using a needle-type grease gun, push new grease into the two Switch Infinity grease ports until you see grease extruding from the shaft seals.



07.
Install the Main Pivot Collet Wedge and
***Torque to 14 Nm.**

FRAME ASSEMBLY

YETI TIPS

Make sure your tools are in good condition. A worn allen key can round the hex on a bolt not allowing for proper torque.

Torque settings are listed throughout the instructions. It is important to prep all bolt threads. The instructions denote whether to use a Loctite compound or grease.

Warning: Service on Yeti bicycles requires special knowledge and tools. Yeti Cycles recommends that all service and repairs be performed by an authorized Yeti Dealer

TOOLS NEEDED

- 3mm allen key
- 4mm allen keys
- 5mm allen keys
- 6mm allen key
- 10mm allen key
- Guide pin tool (Or two)
- Cassette tool
- Torque wrench
- Grease
- Blue (243) Loctite



01.

All the parts you'll need to get your SB150 frame assembled. Please refer to the exploded view later in this manual for more information.



02.

Press the Shock Eyelet Spacer into the rear shock eyelet using an arbor press or vise.



03.

Apply a light coat of grease to the threads of the Rear Triangle at the Seat Stay Pivots. Install 2x Bearing Lockring (200020311) with a cassette tool.

***Torque to 20 Nm.**



04.

Slide 4x Washer (300030214) over 4x M6 Cap Screw (300030057) and apply Blue Loctite (243 or similar) to the threads.

Insert the 4x Cap Screws into the frame and place a black Infinity Link washer on each bolt. Orient the washers such that the flat surfaces are facing the window in the frame where the Switch Infinity Link is mounted.



**05.**

Install the Switch Infinity Link into the frame by rocking it into place over the bolts and black Switch Washers. The grease zerks should face the non-drive side. Tighten the 4x bolts by hand, then torque in a cross pattern to **12 Nm**

**06.**

Apply a light coat of grease to the inner surfaces of 2x Extender Bearing Races (300040505). Place one each into the Upper and Lower Shock Extenders (200020322 and 200020323).

**07.**

Place the Upper and Lower Extenders together so that the bearings touch in the middle. Orient the Upper threaded extender toward the top and slide into the Link (200020321). Secure with a Guide Pin.

**08.**

Slide a 41mm Titanium Female bolt with Washer (300030069) through the Link/Extender Assembly. Secure with a Ti Male Bolt (300030151) & Washer (300030062).

***Torque to 10 Nm.**

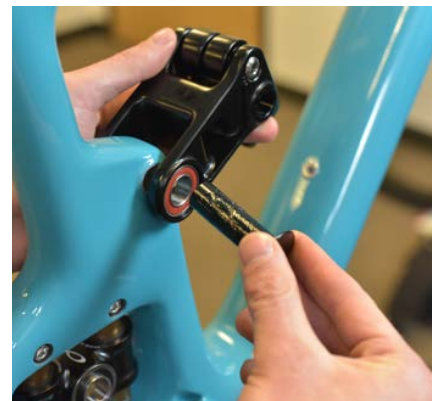
**09.**

Grease shaft of the Link Pivot Female Bolt (200020328). Place the Link onto the Front Triangle as shown and secure with Link Pivot Female Bolt. Install Link Pivot Male Bolt (300030293).

***Torque to 15 Nm.**

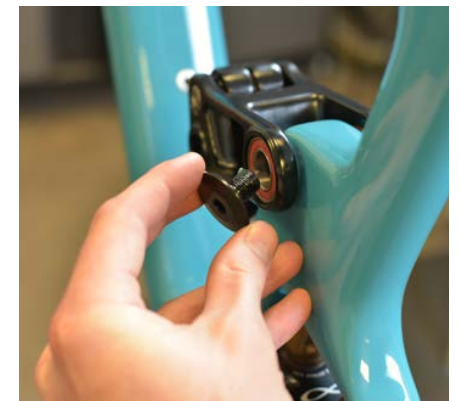

ASSEMBLY



10.

Apply a light coat of grease to the Rear Triangle in the Main Pivot bores and grease the shaft of Main Pivot Collet Axle (300040485). Slide the Rear Triangle over the Switch Infinity Link and install Main Pivot Collet Axle (300040485) through assembly. Install Collet Nut (300030285) and tighten Axle until any play is removed.

**Torque to roughly 12 Nm*

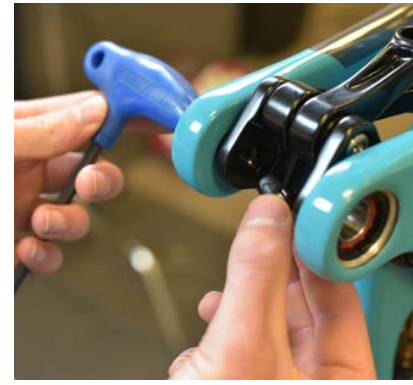

12b.

Rotate Swingarm Forward and move Upper and Lower Shock Extenders out of the way.

Install one Keyed Bolt (200020327) from the inside of the link, threading the Female Bolt onto it. Draw the Keyed Bolt into assembly and make sure its key nests into the keyway on the Link bore.



12c.

Torque Seatstay Pivot Female Bolt to **16 Nm**

Repeat process for opposite side.



11.

Grease threads and wedge of Large Collet Wedge Bolt (300040454). Install into the Main Pivot Axle and **Torque to 14 Nm**



12a.

Grease shaft of 2x Seatstay Pivot Female Bolt (200020326).

Install one Seatstay Pivot Female Bolt (200020326) through the Rear Triangle and into the link.



13.

Open the Upper and Lower Shock Extenders and position the Shock into the frame, allowing it to sit between the two Extender jaws. Secure front eyelet with a Guide Pin



14.

Install Collet Axle (300030296) from the Lower Extender through the Shock and threading into the Upper Extender.

**Torque to 13 Nm*





15.
Grease threads and wedge of small Collet Wedge Bolt (300040486) and install into short Collet Axle.

**Torque to 8 Nm.*



16.
Install 45mm Titanium Female Bolt (300030297) with Washer (300030069) through the front shock mount.



17.
Secure front shock mount with Titanium Male Bolt (300030151) and Washer (300030062).

**Torque to 10 Nm*



18.
Install 2x Washer (300030148) onto 2x H20 Bolt (300030010) and grease threads. Install into front triangle and secure hand tight.

**Torque to 4-5 Nm*

SHOCK SETUP

<https://www.yeticycles.com/bikes/sb150/?guide:support-shock-setup>



19.
Install Lower Cable Port Cover (300040504) onto bottom of frame and secure with Flat Head Bolts (300030299).

**Torque to 4-5 Nm*



20.
Grease outer surface of Derailleur Hanger (300060073). Install into Rear Triangle and secure with Hanger Cap (300060075).

NOTE: HANGER IS REVERSE THREADED

**Torque to 10 Nm*

FOX TRANSFER POST INSERTION GUIDE

MEASURE FROM TOP OF SEAT TUBE TO BOTTOM OF DROPPER POST BODY AS SHOWN BELOW (MEASUREMENTS IN MM)

		FOX TRANSFER POST SIZE		
		125	150	175
FRAME SIZE	SM	200	205	205
	MD	220	245	245
	LG	220	245	270
	XL	220	245	270
		MAX INSERTION (X)		

EXPLODED VIEW

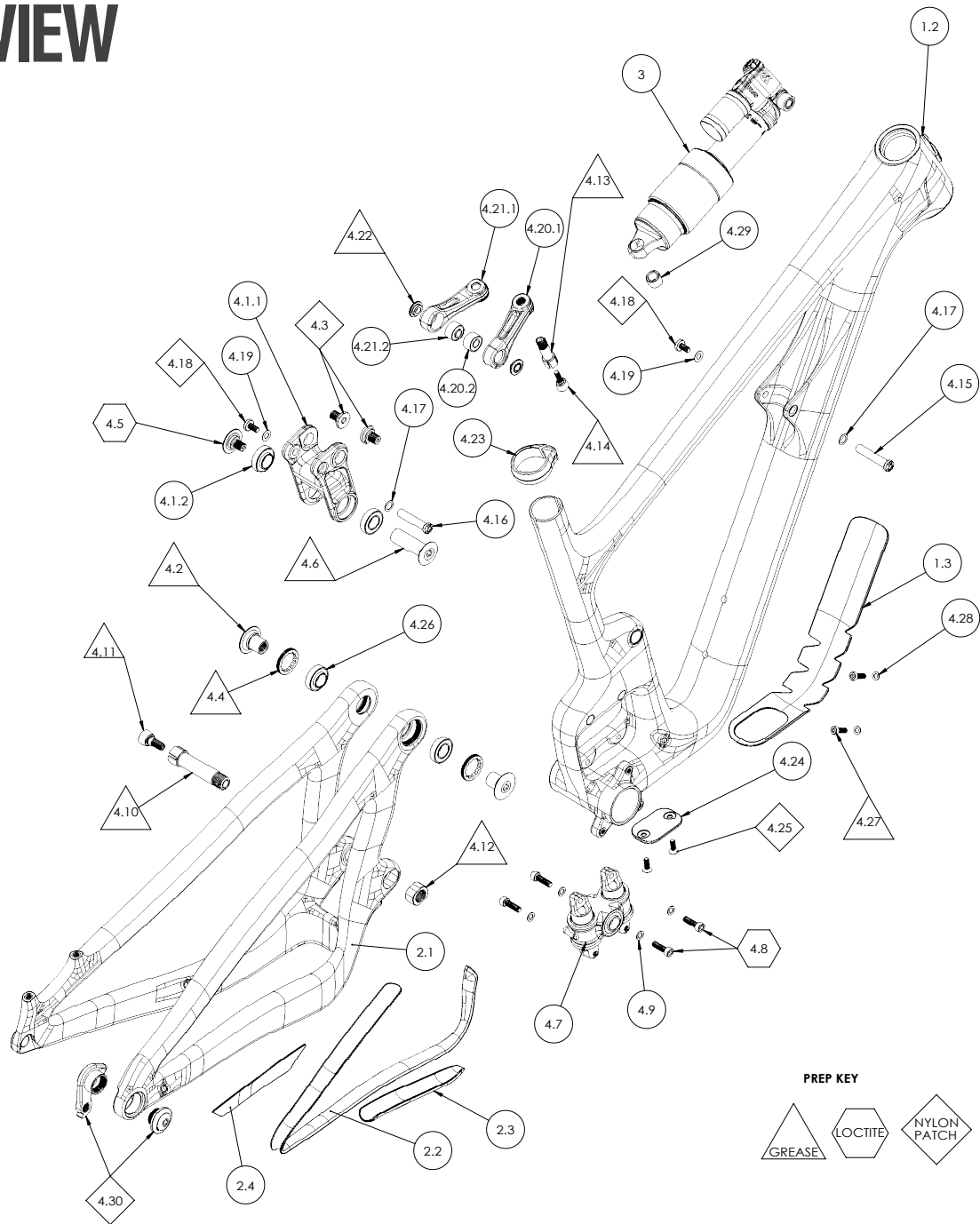

EXPLODED VIEW PARTS LIST

ITEM#	PART #	DESCRIPTION	QTY
1	N/A	SB150 FRONT TRIANGLE ASSEMBLY	
1.1	N/A	SB150 FRONT TRIANGLE	1
1.2	300070006	ICE AXE HEAD BADGE	1
1.3	400100186	DT PROTECTOR	1
2	N/A	SB150 SWING ARM ASSEMBLY	
2.1	N/A	SB150 SWING ARM	1
2.2	400100189	SB150 PROTECTOR CS/SS	1
2.3	400100190	SB150 PROTECTOR CS - LOWER	1
2.4	400100193	SB150 CS PROTECTOR - INNER	1
3	N/A	SB150 SHOCK ASSEMBLY	
4	N/A	SB150 SMALL PARTS ASSEMBLY	
4.1	N/A	SB150 LINK SUB-ASSEMBLY	1
4.1.1	300040501	SB150 LINK	1
4.1.2	300020052	BEARING 6902-2RS EXTENDED, 15 X 28 X 7/10	2
4.2	200020326	BOLT, SS PIVOT, FEMALE	2
4.3	200020327	LINK PIVOT HARDWARE, KEYED, LONG	2
4.4	200020311	LOCKRING, 6902-2RS	2
4.5	300030293	LINK, PIVOT HARDWARE, MALE, 15MM	1
4.6	200020328	STUD, LINK BEARING, FEMALE, 15MM	1
4.7	200020201	SWITCH INFINITY G1 MECHANISM	1
4.8	300030057	BOLT, M6 X 1.0, 20L	4
4.9	300030214	WASHER 6.3X10X1 MM	4
4.10	300040485	COLLET AXLE 15MM	
4.11	300040454	COLLET WEDGE SUB-ASSEMBLY 15MM	1
4.11.1	300030268	COLLET BOLT M8 X 1.25	1
4.11.2	300030267	COLLET WEDGE 15MM	1
4.11.3	300040450	SPIRAL RETAINING RING 0.37 X 0.349 INCHES	1
4.12	300030285	COLLET NUT M15 X 1.5	1
4.13	300030296	COLLET AXLE 30.5 X 10.5 M10 X 1.0	1
4.14	300040486	COLLET WEDGE SUB-ASSEMBLY 10 MM	1
4.14.1	300030284	COLLET BOLT M5 X .8	1
4.14.2	300030283	COLLET WEDGE 10MM	1
4.14.3	300040482	SPIRAL RETAINING RING 0.25 X 0.22 INCHES	1
4.15	300030297	BOLT MASTER, TI FEMALE, 8 X 45.0	1
4.16	300030298	BOLT MASTER, TI FEMALE, 8 X 41.0	1
4.17	300030069	WASHER 8.5 X 12.5 X 0.5 MM	2
4.18	300030151	BOLT, TI MALE, M6 X 12.0 MM	2
4.19	300030062	WASHER 6.5 X 12.5 X 0.5 MM	2
4.20	200020322	ASSEMBLY SHOCK EXTENDER TOP (60MM)	1
4.20.1	300040502	SHOCK EXTENDER TOP (60MM)	1
4.20.2	300020032	BEARING, 398 MAX DBL, 8X19X10/11	1
4.21	200020323	ASSEMBLY SHOCK EXTENDER, BOTTOM (60MM)	1
4.21.1	300040503	SHOCK EXTENDER BOTTOM (60MM)	1
4.21.2	300020032	BEARING, 398 MAX DBL, 8X19X10/11	1
4.22	300040505	SHOCK EXTENDER BEARING EXTENSION	2
4.23	300060078	ASSEMBLY YETI SEAT CLAMP - BOLT ON 31.6	1
4.23.1	N/A	COLLAR, BOLT ON, YETI SEAT CLAMP, 31.6	1
4.23.2	N/A	BARREL NUT, YETI SEAT CLAMP, BOLT ON	1
4.23.3	300030010	BOLT, M5 X 0.8, 16L	1
4.24	300040504	CABLE PORT COVER	1
4.25	300030299	BOLT, FLAT HEAD, M5 X 0.8 X 16	2
4.26	300020052	BEARING 6902-2RS EXTENDED, 15 X 28 X 7/10	2
4.27	300030010	BOLT, M5 X 0.8, 16L	2
4.28	300030148	WASHER 5.1 X 8.9 X 1.0 MM	2
4.29	300030300	SHOCK EYELET SPACER	1
4.30	300060073	12 X 148 HANGER KIT G3	1

REBUILD KITS

PART #	DESCRIPTION	QTY
200020333	SB150 MASTER REBUILD KIT	
200020311	LOCKRING, SS PIVOT	2
200020322	SHOCK EXTENDER 60MM TOP W/BEARING	1
200020323	SHOCK EXTENDER 60MM BOTTOM W/BEARING	1
200020326	BOLT, SS PIVOT, FEMALE	2
200020327	LINK PIVOT HARDWARE, KEYED, LONG	2
200020328	STUD, LINK BEARING, FEMALE 15MM, 48.5L	1
300020045	BEARING F6902 2RS 28X15X7 OUT	2
300020052	BEARING 6902 LLU MAX-E	4
300030057	BOLT CAP M6X1X20	4
300030062	WASHER SS 6.5MM ID 12.5MM	2
300030069	WASHER SS 8.5MM ID 12.5MM	2
300030151	BOLT-TI-MALE M6X12MM	2
300030214	WASHER 10 X 6.2 X 1	4
300030285	COLLET AXLE NUT M15X1.5X12	1
300030293	AXLE, MALE, 15MM X 16MM, M10X1.0	1
300030296	COLLET AXLE 30.5X10.5 M10X1.0	1
300030297	BOLT MASTER, TI FEMALE, 8 X 45.0	1
300030298	BOLT MASTER, TI FEMALE, 8 X 41.0	1
300030299	BOLT, FLAT HEAD, M5 X 0.8 X 16	2
300030300	SHOCK EYELET SPACER	1
300040454	COLLET-WEDGE ASSEMBLY GEN2	1
300040485	AXLE COLLET 15X52.5SX13T	1
300040486	COLLET-WEDGE ASSEMBLY - M10	1
300040504	CABLE PORT COVER	1
300040505	SHOCK EXTENDER BEARING EXTENSION	2

PART #	DESCRIPTION	QTY
200020334	SB150 HARDWARE KIT	
200020311	LOCKRING, SS PIVOT	2
200020322	SHOCK EXTENDER 60MM TOP W/BEARING	1
200020323	SHOCK EXTENDER 60MM BOTTOM W/BEARING	1
200020326	BOLT, SS PIVOT, FEMALE	2
200020327	LINK PIVOT HARDWARE, KEYED, LONG	2
200020328	STUD, LINK BEARING, FEMALE 15MM, 48.5L	1
300030057	BOLT CAP M6X1X20	4
300030062	WASHER SS 6.5MM ID 12.5MM	2
300030069	WASHER SS 8.5MM ID 12.5MM	2
300030151	BOLT-TI-MALE M6X12MM	2
300030214	WASHER 10 X 6.2 X 1	4
300030285	COLLET AXLE NUT M15X1.5X12	1
300030293	AXLE, MALE, 15MM X 16MM, M10X1.0	1
300030296	COLLET AXLE 30.5X10.5 M10X1.0	1
300030297	BOLT MASTER, TI FEMALE, 8 X 45.0	1
300030298	BOLT MASTER, TI FEMALE, 8 X 41.0	1
300030299	BOLT, FLAT HEAD, M5 X 0.8 X 16	2
300030300	SHOCK EYELET SPACER	1
300040454	COLLET-WEDGE ASSEMBLY GEN2	1
300040485	AXLE COLLET 15X52.5SX13T	1
300040486	COLLET-WEDGE ASSEMBLY - M10	1
300040504	CABLE PORT COVER	1
300040505	SHOCK EXTENDER BEARING EXTENSION	2
200020335	SB150 BEARING REBUILD KIT	
300020032	BEARING 398 2RS MAX DBL ROW	2
300020045	BEARING F6902 2RS 28X15X7 OUT	2
300020052	BEARING 6902 LLU MAX-E	4

REBUILD KITS CONTINUED

PART #	DESCRIPTION	QTY
200020039	SB150 PORT COVER KIT	
300030299	BOLT, FLAT HEAD, M5 X .08 X 16	2
300040504	CABLE PORT COVER	1
400100196	SB150 GEN1 PROTECTOR KIT	
400100186	UNIVERSAL DT PROTECTOR	1
400100186	SB150 CS/SS PROTECTOR	1
400100190	SB150 CS LOWER PROTECTOR	1
300040491	SB150 CS INNER PROTECTOR	1

LIFETIME WARRANTY

HERE'S EVERYTHING YOU NEED TO KNOW ABOUT OUR LIFETIME WARRANTY:

All 2019 (or newer) frames, including the Switch Infinity, are covered for life against damage due to manufacturing defects for the original purchaser. Paint and finish are covered for 1-year. We will repair or replace, at our discretion, any frame we deem defective. There are a few conditions: you must register it online at YetiCycles.com and you must take it to an authorized Yeti Cycles dealer for processing. Warranty does not cover damage due to ordinary wear and tear, neglect or intentional destruction. From a slingshot or your truck.

If you happen to have a crash or non-warranty situation, we'll get you back on the trail with a reasonable replacement price. Same conditions as above.

Lifetime Warranty applies to all 2019 and newer frames (including the SB100). Model year 2018 and older frames will be covered under our previous warranty (5-year or 2-year based on time of purchase).

Simple as that. No fine print.

DISCLAIMER

YETI Cycles is not responsible for any damages to you or others arising from riding, transporting or other use of your bicycle. In the event that your frame breaks or malfunctions, YETI Cycles shall have no liability or obligation beyond the repair or replacement of your frame pursuant to the terms outlined in the warranty.

**If you have a warranty concern, please contact your authorized Yeti dealer.*

YETI CYCLES

621 Corporate Circle, Unit B
Golden, CO 80401
(p) 303-278-6909
(f) 303-278-6906
www.yeticycles.com

BUSINESS HOURS

Monday-Friday
8AM-11:30AM, 1:00PM-5:30PM
(Mountain Time)